

# mitsubishi

Refrigerator-Freezer

MR-H290S

OPERATING  
INSTRUCTIONS

# Easy Refrigerator Use

## CONTENTS

### Before using your refrigerator

From installation to operation 2

### Using each compartment

Compartment name and use 3

Usage : Controlling Temperature for Each Compartment 4

Effective Use of your refrigerator 4

Usage : Freezer Compartment 5

Usage : Refrigerator Compartment 6

### Maintenance and troubleshooting

Removing and maintaining 7

What to do (during, long periods of non use, and transport) 7

### Safety precautions 8

### Troubleshooting 9

### Specifications 10



- Please read this manual carefully and follow the information contained within. In particular, be sure to read the safety precautions before using this refrigerator.
- Be sure to receive your copy of the warranty from the retailer and confirm that the purchase date and retailer name are written on the warranty.
- Store this operating instructions manual and the warranty in a safe place.

- This refrigerator was manufactured for refrigerating and freezing of foods in general households. For commercial use, please use a commercial refrigerator-freezer.
- The principal plastic components indicate the material name to facilitate recycling.

# From Installation to Operation

## Installation location

The installation location should be a well-ventilated area out of direct sunlight and not exposed to hot air

- to avoid diminished cooling power and to economise on electricity costs.

### Low humidity

- is recommended to prevent rusting.

### Strong and level location

- is recommended to prevent vibration and noise.

If the refrigerator is installed on flooring on which the refrigerator supports easily sink (such as carpeting, woven mats, polyvinyl chloride flooring, etc.) place a strong plate or board under the refrigerator. (This is necessary to prevent deformation or discoloration due to heat.)

### Away from other household appliances

- is recommended to prevent noise or image interference with televisions, etc.

## Leave space for heat ventilation

Leave at least 2 cm. of space to the left and right of the refrigerator and at least 10 cm. of space above the refrigerator

to allow heat to escape from above and to the sides of the refrigerator.

### The exterior of the refrigerator gets hot

When the refrigerator is first used and during the summer, the exterior temperature can exceed 50-60 °C.

## Electrical Connections

### Make sure this unit is properly grounded.

- The unit should always be plugged into its own electrical outlet. This will provide the best performance and prevent electrical circuits from being overloaded and causing a fire. Make sure that the electrical outlet provides the proper voltage. Extension cords are not recommended.
- If your power cord has a 3-pin power plug and the electrical outlet is not equipped with such a plug, change the electrical outlet, not the power plug. Do not cut or remove the 3-pin power plug.
- If the power cord is damaged, purchase a new cord from MITSUBISHI SERVICE CENTER. Make sure that the power cord is designed for this model.
- If the power cord is damaged, call our MITSUBISHI SERVICE CENTER for the replacement, in order to avoid a hazard.

- This refrigerator uses flammable foaming gas for insulation.
- Please deliver the unit to specialised industrial waste dealer when you dispose of it.
- Please follow the rules in your country.

## Adjust support for level installation

Turn the adjustable supports located at the bottom front of the refrigerator for a level installation.

to prevent vibration, noise, refrigerator movement, and doors that do not close properly.



Adjustable support

### Caution

If the refrigerator is not installed properly, it can move and cause injury.

When it turns to the direction of the arrow, it becomes high.

## Prepare for earthquakes

Thread strong belts through the 2 hand-grip recesses on the upper rear of the refrigerator and secure them to the wall, posts, or other strong area.

Consult the refrigerator retailer for tip-prevention belts for your refrigerator (sold separately)

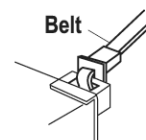

Belt

### Warning

Your refrigerator can cause injury if it tips over.

## Use a dedicated outlet

Use a dedicated outlet for the power supply that meets the rating specified on the rating label. (The rating label is located on the door-liner of the refrigerator compartment)

### Warning

Using outlets that do not meet the specified rating or plugging in too many leads into a single socket can cause heat build up or fire

## To ensure quick cooling

The refrigerator will not immediately cool after power is turned on. It normally take 4 - 5 hours for the refrigerator too cool.

Especially during hot summers, it may take 24 hours to make the first batch of ice.

- Leave space between food items.
- Allow the refrigerator to cool sufficiently before you store non-cooled food items or ice cream.
- Open and close the doors only as much as necessary and do not leave them open for long periods of time.

# Compartment name and Use

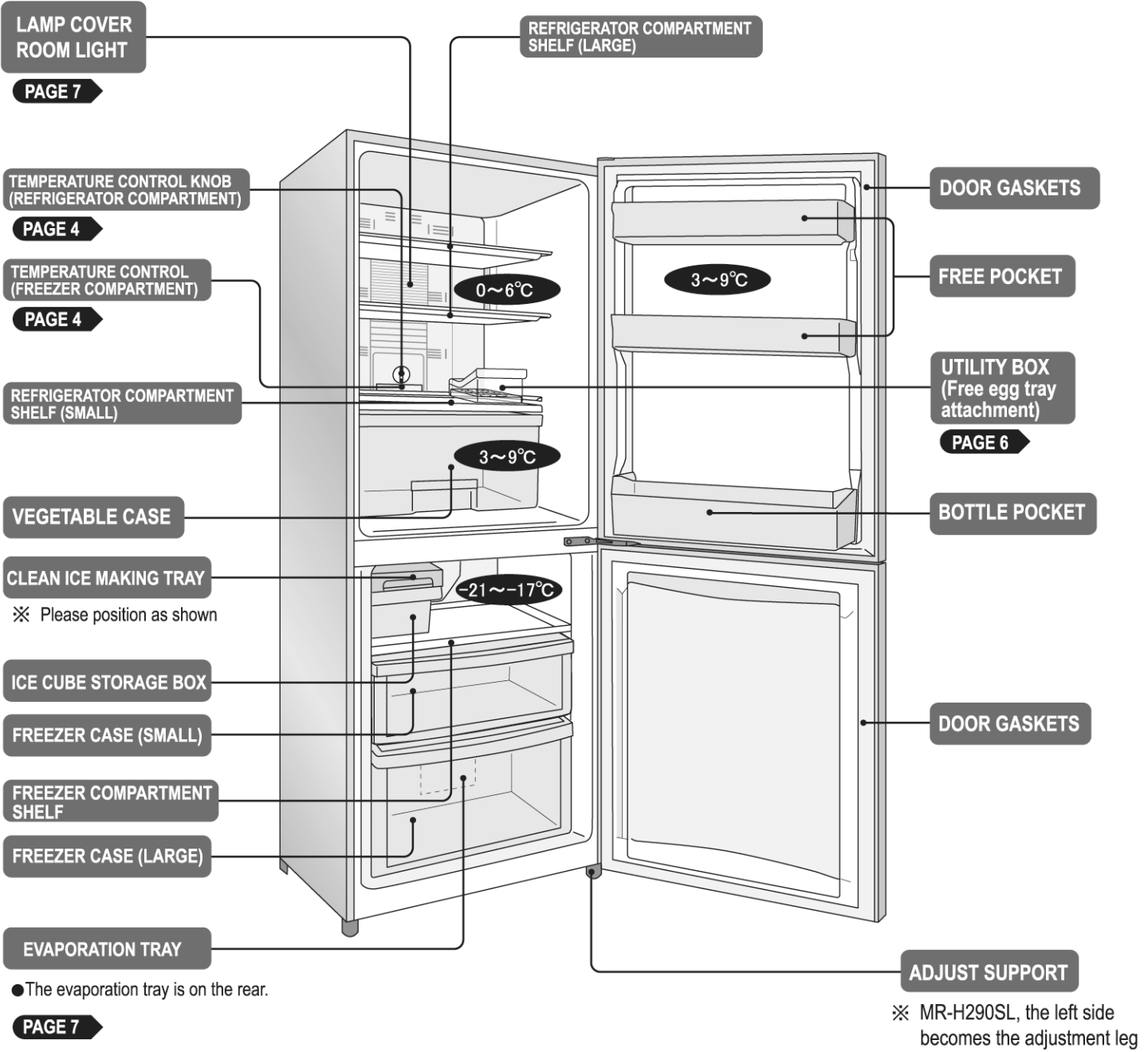

**USER TRIP**

● The temperature listed above for the refrigerator and freezer compartments represent the temperatures measure roughly at the lower center of each compartment with the temperature control knob set between the COLDER and WARMER settings, the refrigerator empty, the doors closed, and a stable ambient temperature of 30°C

# Controlling Temperature for Each Compartment

## REFRIGERATOR COMPARTMENT

Should normally be used with the [ MID ] setting.

### REFRIGERATOR CONTROL

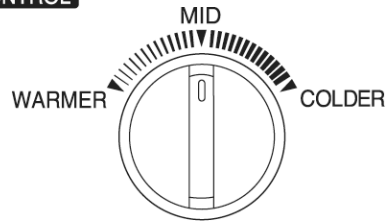

Control Knob Setting	Usage
COLDER	For stronger cooling, or in summer when the ambient temperature is high.
MID	Normal
WARMER	In case of overcooling or freezing.

## FREEZER COMPARTMENT

Should normally be used with the [ MID ] setting.

### FREEZER CONTROL

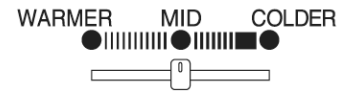

Control Knob Setting	Usage
COLDER	In winter when cooling in the Freezer Compartment is weak, or for stronger cooling.
MID	Normal
WARMER	When there are no frozen foods in the compartment or when storing frozen foods for shorter periods (approx. 1 month).

There are cases where temperature adjustment is required depending on the room temperature.

In winter when cooling in the Freezer Compartment is weak.

- Cases where cooling in the freezer compartment is weak even when the Freezer Compartment knob is set to [ COLDER ], for example, when the ambient temperature is low in winter.

Set the Freezer Compartment knob to [ COLDER ]. Turn the Refrigerator Compartment knob to [ COLDER ].

- This is because the compressor operates according to the temperature of the Refrigerator Compartment.
- The overall cooling effect increases, and the Freezing Compartment also becomes colder.
- ※ When the ambient temperature increases in spring, etc., return each knob to the [ MID ] position.

When cooling in the refrigerator compartment is weak, such as in summer.

- Cases where cooling in the refrigerator compartment is weak in summer, etc. when the knob on the freezer compartment is set to [ COLDER ]
- If cooling in the refrigerator compartment is weak even when the knob for the refrigeration compartment is set to [ COLDER ], such as in summer when the ambient temperature is high or there is frequent opening and closing of the refrigerator door.

Return the knob on the freezing compartment to [ WARMER ].

- Cold air is sent in larger amounts to the refrigerator compartment.
- ※ If the knob on the freezer compartment is set constantly to [ WARMER ], the frozen foods may become soft.

## Effective Use of your refrigerator

### Energy-Saving

Too many items in the refrigerator decrease the cooling efficiency.

- Make sure there is space between items.
- Avoid frequent opening and closing of the refrigerator door or leaving the door open.

Even a slight opening of the door can lead to frost buildup and poor cooling.

- Make sure that no food items, plastic bags or electric cords, etc. are pinched by the door when closing.

### To avoid freezing of foods in the refrigerator compartment.

- The temperature adjustment knob should be returned to the [ MID ] position except when extra cooling is required.
- Store beverages or foods with a high liquid content in the front of the refrigerator.

### Points to remember when inserting goods

- Wrap or cover items to prevent them from drying out and to prevent odors.
- Allow hot items to cool off before placing them in the refrigerator.

# Usage : Freezer Compartment

## Ice-Making: Making good-tasting ice with high transparency.

1 Assemble the upper and lower trays and fill with water, making sure not to exceed the level indicated by the arrow.



2 The upper tray produces ice with high transparency.

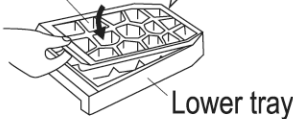

3 When the ice is ready, bend the tray with the upper and lower trays still assembled to remove the ice.

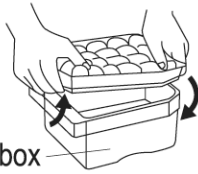

### Note

- The lower tray produces a whiter ice than the top tray due to impurities in the water and should be used when flavour is not an issue.
- If ice-making is carried out with white ice in the lower tray, it will not be possible to produce ice with high transparency. Remove the ice in the lower tray before making ice.
- If the ice-making trays are bent as shown in the picture or excessive force is applied, this could lead to cracking of the trays. In case of cracking, discontinue use.
- Do not make ice in the ice storage box as this could cause cracking of the box.



### User tip

- Making ice in the upper tray takes longer as the ice maker removes bubbles and minerals from the tap water. The ice-making time depends on the amount of water used.
  - ※ When using only the lower tray, it is not possible to produce ice with high transparency.
- Ice made with mineral water or water with a high mineral content may have white sediment (white crystals). This is not harmful as this happens when the mineral content crystallizes.
- If ice is kept in the freezer for longer periods, the individual ice cubes might join together or become smaller (as a result of the phenomenon known as sublimation).
- There may be white areas or bubbles in the ice.
- The transparency of the ice could change in the following cases due to creating more white sections.
  - When using water with a high hardness level (mineral sediment in the ice).
  - The ambient temperature or the usage condition of the refrigerator changes.
  - When ice is stored for long periods in the ice storage box. (This causes frost on the ice surface. Frost can be removed by placing it in water).

## Removing and inserting the freezing cases (large and small)

Use the reverse order when inserting the cases.

- 1 Pull the freezing case all the way out.
- 2 Lift up in your direction to pull and remove.

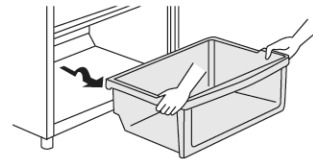

### Note

- Make sure that no food items are protruding from the freezing case when storing them.
- A protruded food item could prevent full closing of the door, causing frost buildup in the freezer and poor cooling or equipment failure.
  - Could cause damage to foods or the freezing case.
  - After inserting foods, make sure that the freezing case is definitely inserted all the way to the back to prevent partial opening of the freezer door.

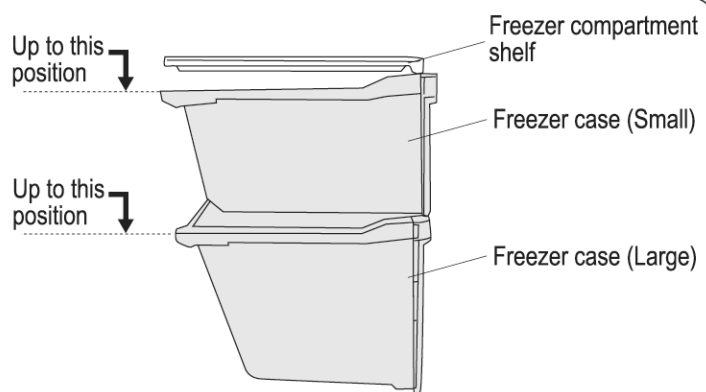

# Usage : Refrigerator Compartment

## Utility Box, Free egg tray

Can be used for various purposes.

### Storage of eggs and small items

- Can be used by inserting the free egg tray in the egg and small-item case.

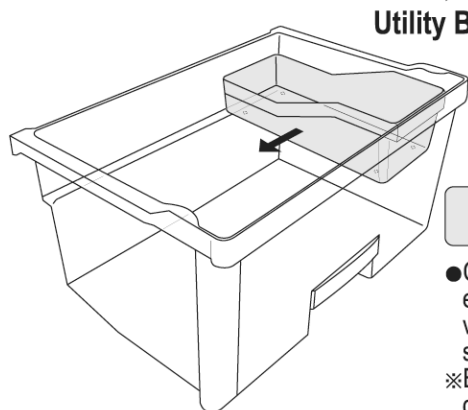
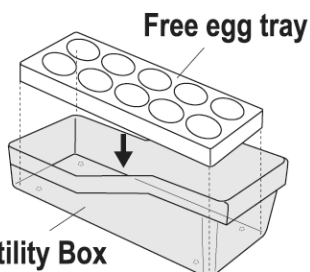

### Storage of fruits and smaller vegetables

- Can be used by inserting the egg and small-item case in the vegetable case (can be slid sideways).
- ※ Be sure to insert in the direction shown in the picture.

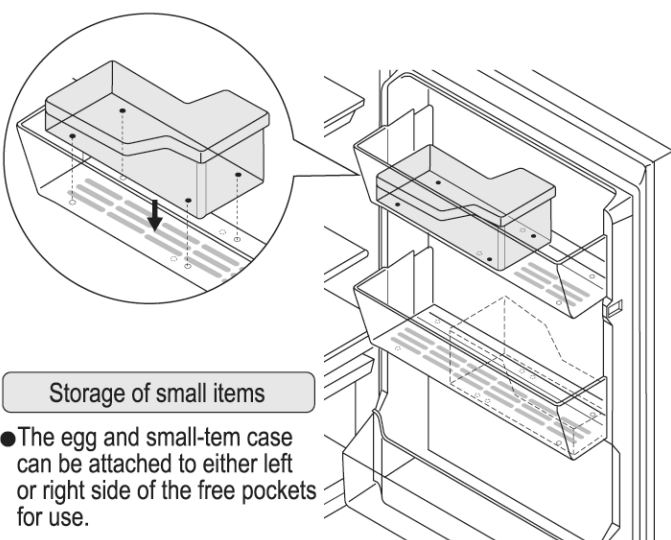

### Storage of small items

- The egg and small-item case can be attached to either left or right side of the free pockets for use.

## Vegetable Case

Sliding case for easy opening

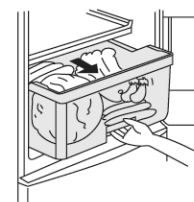

- We recommend wrapping vegetables and fruits in kitchen wrap before storing in the refrigerator to help preserve freshness for longer time.
- There is an anti-freeze heater in the refrigerator floor below the vegetable case to prevent items from freezing. Never place items directly in contact with the floor without the case.

## Note

- Do not leave food items hanging over the edge of each shelf.
- Do not place bottles or other items in the front of the bottle pocket that do not fit completely in the pocket.
  - ※ This will stop the door from closing properly and could break bottles.
- Do not close the refrigerator door with items left in front of the vegetable case.
- Place items completely in the vegetable case.
- Do not attach anything to the outside of the pocket.
  - ※ This will prevent the door from closing properly and could damage the vegetable case.



## Removing and Reinstalling

- Reverse the removal procedures to reinstall the accessories.

### Free pocket and Bottle pocket

- 1 Lift up the left and right sides alternately. (The pocket are installed securely.)
- 2 Pull towards you.

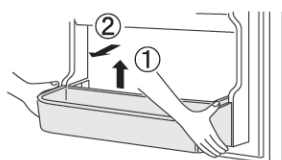

### Vegetable case

- 1 Pull the vegetable case all the way out.
- 2 Lift up in your direction to pull and remove.

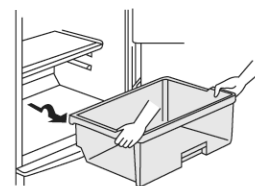

# Removing and Maintaining

## Before you start maintenance

**Remove the power cord plug from the outlet.**

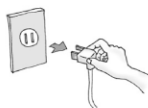

Wait at least 10 minutes before you plug the power cord plug back into the outlet. The refrigerator will not operate if the plug is reinserted soon after it is removed.

### Warning

Failure to remove the power cord plug can cause electric shock

## How to maintenance

### Cleaning

- Wipe or remove and wash with water.
- To remove oily deposits, wet a cloth with lukewarm water or dishwashing detergent and wipe clean. (deposits left on plastic parts can cause them to break)
- Be sure to completely wipe off any detergent you use.
- For chemically-treated disposable cloths, be sure to read all of the instructions and observe the precautions.
- Do not use alcohol, benzene, scouring brushes, or alkaline detergent. They can damage the surface of plastics parts (door handles, cap, case, etc.) and cause them to break.



### Rear of the refrigerator and floor

- ① The refrigerator is pulled out forward.
- ② Wipe away any dirt from the wall floor, or rear of the refrigerator. Air circulation can cause dust to collect in the area behind and under the refrigerator. These areas also easily become black.

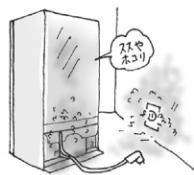

### Caution

Do not touch the compressor at the bottom of the refrigerator - it can become very hot.  
Do not put your hands into the bottom opening of the refrigerator. (Doing so can cause injury)

### Replacing the interior light bulb

- ① Remove the power cord plug from the outlet.
- ② Remove the refrigerator compartment shelf (Large).
- ③ Push the side nail of both the right hand side and left hand side, pull the cover forward and then remove the light cover.
- Purchase a 240V 15W glass light bulb (metal cap E-12) from your refrigerator retailer.
- ④ Replace the interior light bulb.
- ⑤ To reinstall the cover, insert the upper nail and then the side nails.

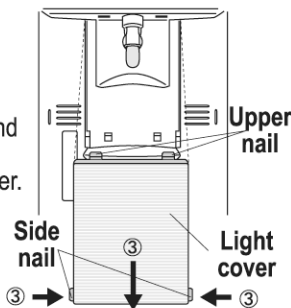

### Warning

Using non-specified light bulbs can cause a fire.

### How to remove the drain pan

- ① Pull the refrigerator away from the walls.
- ② Remove the drain pan as shown.
- ③ When removing the drain pan, pull up on the drain pan at a slight angle so it does not contact the drainpipe.
- ④ To install, insert the drain pan completely so the drainpipe is located above the drain pan. (Failure to insert the drain pan completely can lead to water leaks, noise, and vibration.)

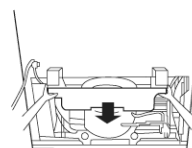

## After maintenance

### Inspecting the power cord, plug, and outlet

- Is the power cord or plug damaged?
- Has dust collected on the power cord plug?
- Is there abnormal heat buildup in the power cord plug?
- Is the outlet loose?



- Is the power cord plug inserted securely into the outlet?

### Warning

Damage to the power cord or plug or dust buildup can cause electric shock or a fire.

## What to do

### Blackouts (electric power goes out)

- Refrain from opening and closing the refrigerator doors and avoid storing additional food items in the refrigerator.

### Long periods of nonuse

- After removing the power cord plug from the outlet, clean the interior of the refrigerator and leave the doors open for 2-3 days to let interior dry completely.
  - ※ Failure to let the interior of the refrigerator dry completely can cause molding, odors, and refrigerant (gas) leakage due to corrosion of the condenser.

### Transporting the refrigerator

1. Discard the water or ice in the ice tray.
2. Discard the water that has collected in the drain pan.
3. Gently transport the refrigerator with 2 or more people, holding the lower front interior and the handy-grip recesses on the upper rear of the unit.
- Do not lay the refrigerator down. (Doing so can cause the compressor to malfunction.)
- If changing residences, it is not necessary to change the frequency of the power supply. (Both 50 and 60 Hz are compatible.)



# Safety Precautions

- Danger and degree of danger caused by improper handling are categorised and described using the following symbols.
- Meaning of symbols.
- In the case of malfunction or defect, immediately turn off the refrigerator and contact your refrigerator retailer, the Mitsubishi Electric Maintenance Service, or representative.

Do not do	Do not touch	Do not attempt to disassemble, repair or alter	Do not get wet or dampen with water
Be sure to follow the instructions as indicated	Be sure to remove the power cord plug from the outlet	Be sure to ground the refrigerator	Do not touch with wet hands.

## Warning

<p><b>Anchor the refrigerator to a strong wall or post to prepare for an earthquake. This will prevent tipping over and causing injury.</b> <b>Page 2</b></p> <p><small>Tip prevention</small></p>	<ul style="list-style-type: none"> <li>● The appliance is not intended for use by young children or infirm persons without supervision.</li> <li>● Young children should be supervised to ensure that they do not play with the appliance.</li> </ul>	<p><b>If the power cord is damaged, call our Mitsubishi Service Center for the replacement.</b></p> <p>If the power cord is damaged, purchase a new cord from Mitsubishi Service Center.</p> <p>Make sure that the power cord is designed for this model. </p>
<p><b>Use a dedicated outlet for the power supply that meets the rating specified on the rating label.</b> <b>Page 2</b></p> <p><small>Only use an outlet that meets the specified rating</small></p>		
<p><b>Do not store medicine or scientific specimens in the refrigerator.</b>  Items that require strict management cannot be stored in household refrigerator.</p> <p><small>Do not store</small></p>	<p><b>Do not use flammable sprays near the refrigerator.</b>  Sparks from electric contact can cause a fire.</p> <p><small>Do not use</small></p>	<p><b>Do not place containers with water on top of the refrigerator.</b>  Wet electrical parts can cause electric shock or a fire.</p> <p><small>Do not get wet</small></p>
<p><b>If you notice a gas leak, do not touch the refrigerator. Open the windows to ventilate.</b>  Sparks from electric contact can cause an explosion or a fire.</p> <p><small>Ventilate</small></p>	<p><b>Do not wash with water or spill food liquids on the refrigerator.</b>  Water and food liquids can cause electric shock or a fire. Clean up spills immediately.</p> <p><small>Do not get wet</small></p>	<p><b>Do not place volatile flammable items inside the refrigerator.</b>  Benzene, cosmetics and hair products can catch fire and explode.</p> <p><small>Do not store</small></p>
<p><b>Do not disassemble, repair or alter.</b>  Doing so can cause injury, electric shock or a fire.</p> <p><small>Do not disassemble</small></p>	<p><b>Before disposing of the refrigerator, be sure to pull the packing off of the doors.</b>  Children can be put in danger if they are trapped in side the refrigerator.</p> <p><small>Remove the packing</small></p>	<p><b>Do not place objects on top of the refrigerator.</b>  The objects may fall when the doors are opened and closed and cause injury.</p> <p><small>Prohibited</small></p>
<p><b>Do not pull on the power cord to remove the plug.</b>  Doing so can damage the power cord and cause electric shock or a fire.</p> <p><small>No wet hands</small></p>	<p><b>Use only interior light bulbs with the special rating.</b>  Using non-specified light bulbs can cause a fire. <b>Page 7</b></p> <p><small>Specified products only</small></p>	<p><b>Remove any dust from the power cord plug.</b>  Insulation failure can cause a fire.</p> <p><small>Remove dust</small></p>
<p><b>Do not use damaged power cords or plug or loose outlets.</b>  Doing so can cause electric shock or a fire.</p> <p><small>Do not use</small></p>	<p><b>Do not pull on the power cord to remove the plug.</b>  Doing so can damage the power cord and cause electric shock or a fire.</p> <p><small>Prohibited</small></p>	<p><b>Remove the power cord plug from the outlet before maintenance or changing the interior light bulb.</b>  Failure to do so can cause electric shock or injury.</p> <p><small>Remove the plug</small></p>
<p><b>In case of a malfunction (burning odour is detected, etc.), remove the power cord plug from the outlet and turn off the refrigerator.</b>  Continued operation of the refrigerator with a malfunction can cause electric shock or a fire.</p> <p><small>Remove the plug</small></p>	<p><b>Do not hang on the door or door handle.</b>  The refrigerator may tip over and cause injury.</p> <p><small>Prohibited</small></p>	<p><b>Do not press the back of the refrigerator against the power cord plug. Do not damage the power cord.</b>  Pressing against, placing weight on, folding, or bundling the power cord can cause electric shock or a fire.</p> <p><small>Do not use</small></p>

## Caution

<p><b>Use the adjusting supports so the refrigerator is securely installed on a strong level surface.</b>  If the refrigerator is not installed properly it could move and cause injury. <b>Page 2</b></p> <p><small>Install level</small></p>	<p><b>Use transportation handholds when transporting the refrigerator.</b>  Holding other parts can cause injury. <b>Page 7</b></p> <p><small>hold the handholds</small></p>	<p><b>Do not excessively pack the refrigerator with food or remove the shelves with excessive force.</b>  Doing so can cause food items to fall and cause injury.</p> <p><small>Prohibited</small></p>
<p><b>Do not place glass bottles in the freezer compartment.</b>  The contents of the bottle can freeze and cause the bottle to break and cause injury.</p> <p><small>Do not store</small></p>	<p><b>Do not eat food that has a strange odour or is discoloured.</b>  Doing so can cause food poisoning or illness.</p> <p><small>Prohibited</small></p>	<p><b>Do not touch food items or containers in the freezer compartment with wet hands.</b>  Doing so can cause frostbite.</p> <p><small>No wet hands</small></p>
<p><b>Do not put your hands or feet underneath the refrigerator.</b>  The metal plates, etc., on the bottom of the refrigerator can cause injury.</p> <p><small>Do not touch</small></p>	<p><b>Do not put your hands or feet underneath the refrigerator.</b>  Use the door handle to close the door.</p> <p><small>Hold the door handle</small></p>	



# Troubleshooting

If the problem is not resolved after troubleshooting, contact the distributor - see the last page - for assistance.

Problem	Check the following	Solutions and reasons
Refrigerator does not cool	<ul style="list-style-type: none"> <li>① Is the refrigerator receiving power?</li> </ul>	<ul style="list-style-type: none"> <li>① Check the power cord plug and the circuit breaker.</li> </ul>
Refrigerator does not cool sufficiently ; refrigerator produces little ice or ice melts	<ul style="list-style-type: none"> <li>① Is the temperature control knob set to MID or a left of MID?</li> <li>② Has the refrigerator just been installed?</li> <li>③ Is there sufficient space around the refrigerator? Is the refrigerator in direct sunlight or is heat ventilation hampered?</li> <li>④ Have you blocked the flow of refrigerator air? Is the door opened frequently or left ajar?</li> </ul>	<ul style="list-style-type: none"> <li>① Adjust the temperature control knob to a cooler setting (towards COLDER) <b>Page 4</b></li> <li>② It sometime takes 24 hours for the refrigerator to cool in the summer.</li> <li>③ Check that the refrigerator is installed and set up correctly. <b>Page 2</b></li> <li>④ Check that the refrigerator is not excessively packed with food items and that the doors are not ajar. <b>Page 2</b></li> </ul>
Items in refrigerator compartment begin to freeze	<ul style="list-style-type: none"> <li>① Is the temperature control knob for the refrigerator compartment set to COLDER ?</li> <li>② Have you placed items with high water content in the back of the refrigerator.</li> <li>③ Is the ambient temperature less than 5°C?</li> </ul>	<ul style="list-style-type: none"> <li>① Adjust the temperature control knob to a warmer setting (towards MID). <b>Page 4</b></li> <li>② Store beverages and food items that have high water content such as vegetables and fruit in the front of the refrigerator.</li> <li>③ Set the temperature control knob to MID so food items will not freeze easily.</li> </ul>
Condensation collects on the exterior of the refrigerator and frost collects in the freezer compartment	<ul style="list-style-type: none"> <li>① Is the door opened frequently or left ajar?</li> <li>② Is it a rainy or highly humid time of the year?</li> </ul>	<ul style="list-style-type: none"> <li>① Condensation and frost can form if the doors are only slightly ajar and the moisture in the air cools.</li> <li>② Condensation may temporarily collect on the refrigerator. Wipe the refrigerator with a dry cloth. In addition, frost may form easily in the freezer compartment. Open and close the freezer compartment door only as much as necessary.</li> </ul>
Doors are easy to open or difficult to close	<ul style="list-style-type: none"> <li>① Is any food item contacting a door? Is the refrigerator excessively packed with food items?</li> <li>② Has any food item dropped behind the case in one of sliding doors or is the power cord pinched between the door and the refrigerator?</li> <li>③ Is the refrigerator installed on an uneven surface? Are the adjusting supports contacting the floor?</li> </ul>	<ul style="list-style-type: none"> <li>① Do not store food items so that they stick out from the shelves or cases.</li> <li>② Remove any dropped or pinched item. Be careful not to pinch items such as food items, the power cord, or plastics bags between the door and the refrigerator.</li> <li>③ Lower the adjusting supports to raise the front of the refrigerator and make closing the doors easier. <b>Page 2</b></li> </ul>
Loud or disturbing noises. The noises listed to the right are normal	<ul style="list-style-type: none"> <li>① After defrosting it is normal for the sound level to increase.</li> <li>② Sometimes, a whirring or rumbling sound is heard.</li> <li>③ Sometimes after opening a door, a cracking sound or the sound of dripping water is heard from within the refrigerator.</li> </ul>	<ul style="list-style-type: none"> <li>① After the defrosting, there are times when sound becomes large.</li> <li>② These are the sounds of the flowing refrigerant (gas).</li> <li>③ A creaking or cracking sound is made when warm air has entered the refrigerator, causing the plastic parts to expand.</li> </ul>
Exterior get hot		<p>The refrigerator is equipped with piping to prevent condensation and for heat ventilation from the sides and above the unit. When the refrigerator is first used and during the summer, warm air can flow from under the refrigerator, especially when the exterior temperature is 50-60°C. This is necessary for cooling and is not a malfunction.</p>

# Specifications

<b>Model name</b>		<b>MR-H290S</b>
<b>Type</b>		<b>Refrigerator-Freezer</b>
<b>Volume</b>		<b>290L</b> ( Refrigerator room : 175L Freezer room : 115L
<b>Outside dimension</b>	<b>Width</b>	<b>555mm</b>
	<b>Depth</b>	<b>635mm</b>
	<b>Height</b>	<b>1610mm</b>
<b>Weight</b>		<b>54kg</b>
<b>Voltage</b>		<b>230V/240V</b>
<b>Frequency</b>		<b>50/60 Hz</b>

	<b>Accessories</b>	<b>Quantity</b>
<b>Refrigerator compartment</b>	<b>Refrigerator compartment shelf (large)</b>	<b>2</b>
	<b>Refrigerator compartment shelf (small)</b>	<b>1</b>
	<b>Vegetable case</b>	<b>1</b>
	<b>Utility box (Free egg tray attachment)</b>	<b>1</b>
	<b>Free pocket</b>	<b>2</b>
	<b>Bottle pocket</b>	<b>1</b>
<b>Freezer compartment</b>	<b>Clean ice making tray</b>	<b>1</b>
	<b>Ice cube storage box</b>	<b>1</b>
	<b>Freezer compartment shelf</b>	<b>1</b>
	<b>Freezer case (large)</b>	<b>1</b>
	<b>Freezer case (small)</b>	<b>1</b>
	<b>Drain pan</b>	<b>1</b>

This appliance is designed for use in Australia and New Zealand only and cannot be used in any other country. No service is available outside of Australia and New Zealand.

# Memo

Memo



HEAD OFFICE : MITSUBISHI DENKI BLDG., 2-2-3, MARUNOUCHI, CHIYODA-KU, TOKYO 100-8310, JAPAN  
<http://Global.MitsubishiElectric.com>

---

Distributed by:  
**MITSUBISHI ELECTRIC AUSTRALIA PTY LTD.**  
(Incorporated in New South Wales) ABN 58 001 215 792

**New South Wales:**

348 Victoria Road, Rydalmare 2116 Ph: (02) 9684 7777

**Queensland**

Unit 12, 469 Nudgee Road, Hendra, QLD 4011 Ph: (07) 3263 2000

**South Australia / Northern Territory:**

77 Port Road, Hindmarsh 5007 Ph: (08) 8340 2000

**Western Australia:**

Unit 5, 329 Collier Road, Bassendean 6054 Ph: (089) 9377 3400

**Victoria / Tasmania:**

Unit 4, 303 Burwood Highway, East Burwood 3151 Ph: (03) 9262 9855

---

Distributed by  
**BLACK DIAMOND TECHNOLOGIES LIMITED (BDT)**

**Wellington Office (Head Office)**

1 Parliament Street PO Box 30-772 Lower Hutt Ph: (04) 560 9100, Fax: (04) 560 9133

**Auckland Office**

Unit 1, 4 Walls Road Penrose Auckland PO Box 12-726 Ph: (09) 526 9340, Fax: (09) 526 9369

**Christchurch Office**

Suite 2 Level 1 37 Manderville Street Christchurch PO Box 1604 Ph: (03) 341 7052,

Fax: (03) 341 7054

---